



johnstrand

kitchens for small spaces



pricelist

September 2011

creating **space**

The famous John Strand **Mini-Kitchens**
see brochure pages 4 – 6

WITH HOTPLATES WITHOUT HOTPLATES

Delivery from stock (5 – 7 working days)

MINI-KITCHEN



W:1000 D:600 H:900

MK11
£525

MK17
£480

- Steel construction with white enamel finish
- Stainless steel sink & drainer
- With or without 2 electric hotplates
- 60 minute safety timer with hotplates
- 98ltr refrigerator with 4 star freezer compartment
- Storage cupboard

MINI-KITCHEN
with MICROWAVE



W:1000 D:600 H:900

MK12
£670

MK18
£625

- Steel construction with white enamel finish
- Stainless steel sink & drainer
- With or without 2 electric hotplates
- 60 minute safety timer with hotplates
- 98ltr refrigerator with 4 star freezer compartment
- 700 watt microwave

MINI-KITCHEN
with MICROWAVE
and PAN DRAWER



W:1000 D:600 H:900

MK19D
£715

MK20D
£670

- Steel construction with white enamel finish
- Stainless steel sink & drainer
- With or without 2 electric hotplates
- 60 minute safety timer with hotplates
- 98ltr refrigerator with 4 star freezer compartment
- 700 watt microwave
- Pan drawer below microwave

Kitchenettes see brochure page 8

KITCHENETTE



W:1000 D:600 H:2000

KMK11
£630

KMK17
£585

- Steel construction with white enamel finish
- Stainless steel sink & drainer
- With or without 2 electric hotplates
- 60 minute safety timer with hotplates
- 98ltr refrigerator with 4 star freezer compartment
- Storage cupboard
- 1000 x 300 x 570mm wall unit

KITCHENETTE
with MICROWAVE

W:1000 D:600 H:2000

KMK12
£775

KMK18
£730

- Steel construction with white enamel finish
- Stainless steel sink & drainer
- With or without 2 electric hotplates
- 60 minute safety timer with hotplates
- 98ltr refrigerator with 4 star freezer compartment
- 700watt microwave
- 1000 x 300 x 570mm wall unit

KITCHENETTE
with MICROWAVE
and PAN DRAWER

W:1000 D:600 H:2000

KMK19D
£820

KMK20D
£775

- Steel construction with white enamel finish
- Stainless steel sink & drainer
- With or without 2 electric hotplates
- 60 minute safety timer with hotplates
- 98ltr refrigerator with 4 star freezer compartment
- 700watt microwave
- Pan drawer below microwave
- 1000 x 300 x 570mm wall unit

- Prices are subject to change without prior notice
- All prices exclude VAT
- Delivery costs are charged according to postcode, model and quantity required
- Please refer to separate sheet for delivery charges

Galley Kitchens

see brochure page 9

GALLEY KITCHEN

W:1500 D:600 H:2000

GALLEY KITCHEN with MICROWAVE

W:1500 D:600 H:2000

GALLEY KITCHEN with MICROWAVE and PAN DRAWER

W:1500 D:600 H:2000



WITH HOTPLATES	WITHOUT HOTPLATES
----------------	-------------------

GMK11 £825	GMK17 £780
-----------------------------	-----------------------------

GMK12 £970	GMK18 £925
-----------------------------	-----------------------------

GMK19D £1015	GMK20D £970
-------------------------------	------------------------------

Delivery from stock (5 – 7 working days)

- Stainless steel construction with white enamel finish
- Stainless steel sink & drainer
- With or without 2 electric hotplates
- 60 minute safety timer with hotplates
- 98ltr refrigerator with 4 star freezer compartment
- Storage cupboard
- 500mm base unit & wall unit
- 1000mm wall unit

- Stainless steel construction with white enamel finish
- Stainless steel sink & drainer
- With or without 2 electric hotplates
- 60 minute safety timer with hotplates
- 98ltr refrigerator with 4 star freezer compartment
- 700 watt microwave
- 500mm base unit & wall unit
- 1000mm wall unit

- Stainless steel construction with white enamel finish
- Stainless steel sink & drainer
- With or without 2 electric hotplates
- 60 minute safety timer with hotplates
- 98ltr refrigerator with 4 star freezer compartment
- 700 watt microwave
- Pan drawer below microwave
- 500mm base unit & wall unit
- 1000mm wall unit

Eye Level Micro Kitchens see brochure page 7

Allow 3 – 4 weeks delivery

KITCHENETTE with MICROWAVE

W:1000 D:600 H:2000



ELK11 £715	ELK17 £670
-----------------------------	-----------------------------

- Stainless steel construction with white enamel finish
- Stainless steel sink & drainer
- With or without 2-electric hotplates
- 60 minute safety timer with hotplates
- 98ltr refrigerator with 4 star freezer compartment
- 1000 x 360 x 570mm wall unit with single cupboard and open shelf section
- 700-watt microwave

GALLEY KITCHEN with MICROWAVE

W:1500 D:600 H:2000



ELG11 £915	ELG17 £870
-----------------------------	-----------------------------

- Stainless steel construction with white enamel finish
- Stainless steel sink & drainer
- With or without 2-electric hotplates
- 60 minute safety timer with hotplates
- 98ltr refrigerator with 4 star freezer compartment
- 1000 x 360 x 570mm wall unit
- 500 x 360 x 570 mm open shelf unit
- 700-watt microwave
- 500 x 600 x 900 mm base unit & worktop

Oven Combi Kitchens see brochure page 10

Allow 3 – 4 weeks delivery

OVEN COMBI with MICROWAVE, GRILL & CONVECTION OVEN

W:1600 D:600 H:900



OCMK1 £995	
-----------------------------	--

- Includes MK11 Mini-Kitchen
- 600mm oven housing base unit & worktop
- Cutlery drawer
- Built-in combination Microwave, Grill and Convection Oven
- All units supplied assembled

OVEN COMBI with WALL UNITS

W:1600 D:600 H:2000



OCMK2 £1195	
------------------------------	--





- Includes MK11 Mini-Kitchen
- 600mm oven housing base unit & worktop
- Cutlery drawer
- Built-in combination Microwave, Grill and Convection Oven
- 1000mm wall unit & 600mm wall unit
- All units supplied assembled

Designer Range

Base Units Only

see brochure pages 11 – 13

Check stock availability or allow 4 – 6 weeks for delivery.

	FINISH	2 Hotplates	1 Hotplate	Without Hotplates	
1M BASE  W:1000 D:600 H:900	Finish	ETN1021		ETN1023	<ul style="list-style-type: none"> • White laminate carcass • Stainless steel sink & drainer • 85ltr integrated refrigerator with ice box • Storage cupboard • With or without electric hotplates • 60 minute safety timer with hotplates
	Group 1	£685		£640	
	Group 2	£840		£795	
	Group 3	£885		£840	
1M BASE with DRAWER  W:1000 D:600 H:900	Finish	ETN1041		ETN1043	<ul style="list-style-type: none"> • White laminate carcass • Stainless steel sink & drainer • 70ltr integrated refrigerator with ice box • Storage cupboard • Cutlery drawer • With or without electric hotplates • 60 minute safety timer with hotplates
	Group 1	£700		£655	
	Group 2	£855		£810	
	Group 3	£900		£855	
1.2M BASE  W:1200 D:600 H:900	Finish	ETN1221		ETN1223	<ul style="list-style-type: none"> • White laminate carcass • 1 1/2 bowl Stainless steel sink & drainer • 85ltr integrated refrigerator with ice box • Storage cupboard • With or without electric hotplates • 60 minute safety timer with hotplates • Ceramic hob – Additional cost of £125 only available on ETN1221 (use code ETN1224)
	Group 1	£725		£675	
	Group 2	£875		£825	
	Group 3	£920		£870	
1.2M BASE with DRAWER  W:1200 D:600 H:900	Finish	ETN1241		ETN1243	<ul style="list-style-type: none"> • White laminate carcass • 1 1/2 bowl Stainless steel sink & drainer • 70ltr integrated refrigerator with ice box • Storage cupboard • Cutlery drawer • With or without electric hotplates • 60 minute safety timer with hotplates
	Group 1	£740		£690	
	Group 2	£890		£840	
	Group 3	£935		£855	
600MM BASE with DRAWER  W:600 D:600 H:900	Finish	ETN641	ETN642	ETN643	<ul style="list-style-type: none"> • White laminate carcass • Stainless steel sink top • 70ltr refrigerator with ice box • With or without electric hotplates • 60-minute safety timer with hotplates • Drawer above fridge • Left or right hand hinged door
	Group 1	£635	£620	£595	
	Group 2	£695	£680	£655	
	Group 3	£715	£700	£675	

Please refer to page 18 of colour brochure for Group finishes.

- Prices are subject to change without prior notice
- All prices exclude VAT
- Delivery costs are charged according to postcode, model and quantity required
- Please refer to separate sheet for delivery charges
- ETN1221 model is also available with a single bowl

Designer Range

Kitchens

see brochure pages 11 – 13

FINISH	2 Hotplates with 85ltr fridge	2 Hotplates with 70ltr fridge & drawer	Without Hotplates with 85ltr fridge	Without Hotplates with 70ltr fridge & drawer
--------	-------------------------------	--	-------------------------------------	--

Allow 4 – 6 weeks for delivery.

KITCHENETTE

W:1000 D:600 H:2000



Finish	DK021	DK041	DK023	DK043
Group 1	£805	£820	£755	£775
Group 2	£965	£980	£915	£935
Group 3*	£1035	£1050	£985	£1005

- White laminate carcass
- Stainless steel sink & drainer
- 85ltr refrigerator with ice box
- Storage cupboard
- With or without electric hotplates
- 60-minute safety timer with hotplates
- 1000 x 300 x 570 mm wall unit

KITCHENETTE

with MICROWAVE

W:1000 D:600 H:2000



Finish	DKM021	DKM041	DKM023	DKM043
Group 1	£860	£880	£810	£820
Group 2	£990	£1010	£945	£960
Group 3*	£1040	£1060	£995	£1015

- White laminate carcass
- Stainless steel sink & drainer
- 85ltr refrigerator with ice box
- Storage cupboard
- With or without electric hotplates
- 60-minute safety timer with hotplates
- 1000 x 360 x 570mm wall unit with single cupboard & open shelf section
- 700-watt compact microwave

GALLEY KITCHEN

W:1500 D:600 H:2000



Finish	DG021	DG041	DG023	DG043
Group 1	£1120	£1140	£1075	£1095
Group 2	£1295	£1315	£1250	£1270
Group 3*	£1395	£1415	£1350	£1370

- White laminate carcass
- Stainless steel sink & drainer
- 85ltr refrigerator with ice box
- Storage cupboard
- With or without electric hotplates
- 60-minute safety timer with hotplates
- 1000 x 300 x 570 mm wall unit
- 500 x 300 x 570 mm wall unit
- 500 x 600 x 900 mm base unit with drawer and worktop

GALLEY KITCHEN

with MICROWAVE

W:1500 D:600 H:2000



Finish	DGM021	DGM041	DGM023	DGM043
Group 1	£1195	£1215	£1150	£1170
Group 2	£1350	£1370	£1305	£1325
Group 3*	£1450	£1470	£1405	£1425

* Additional cost for stainless steel longbar handles @ £11.00

- White laminate carcass
- Stainless steel sink & drainer
- 85ltr refrigerator with ice box
- Storage cupboard
- With or without electric hotplates
- 60-minute safety timer with hotplates
- 1000 x 360 x 570 mm wall unit
- 500 x 360 x 570 mm open shelf unit
- 700-watt compact microwave
- 500 x 600 x 900 mm base unit with drawer and worktop

OVEN COMBI KITCHEN

W:1600 D:600 H:2000



Finish	DOC021	DOC041	DOC023	DOC043
Group 1	£1450	£1470	£1410	£1430
Group 2	£1595	£1615	£1555	£1575
Group 3*	£1675	£1695	£1635	£1655

- White laminate carcass
- Stainless steel sink & drainer
- 85ltr refrigerator with ice box
- Storage cupboard
- With or without electric hotplates
- 60-minute safety timer with hotplates
- 1000 x 300 x 570 mm wall unit
- 600 x 300 x 570 mm wall unit
- 600 x 600 x 900 mm base oven housing unit with drawer & worktop
- Combination microwave, grill & convection oven





Please refer to page 18 of colour brochure for Group finishes.

- 1200mm wide Designer Range base units can also be used to create Kitchenettes, Galley & Oven Combi Kitchens

Hideaway Mini-Kitchens

see brochure pages 14 – 17

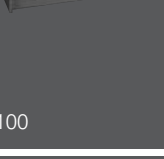
Check stock availability or allow 4 – 6 weeks for delivery.

	FINISH	2 Hotplates	1 Hotplate	Without Hotplates	
1M HIDEAWAY with MICROWAVE  W:1000 D:620 H:2100	Finish	HA05		HA03	<ul style="list-style-type: none"> • White laminate carcass • Stainless steel sink & drainer • 85ltr integrated refrigerator with ice box • Storage cupboard • With or without electric hotplates • 60 minute safety timer with hotplates • Top unit with shelving, light & socket • 700-watt compact microwave • Door activated switch with cut-out to hotplates
	Group 1	£1150		£1100	
	Group 2	£1395		£1345	
	Group 3	£1495		£1445	
1M HIDEAWAY with MICROWAVE and DRAWER  W:1000 D:620 H:2100	Finish	HA07		HA09	<ul style="list-style-type: none"> • White laminate carcass • Stainless steel sink & drainer • 70ltr refrigerator with ice box • Storage cupboard & drawer • With or without electric hotplates • 60 minute safety timer with hotplates • Top unit with shelving, light & socket • 700-watt compact microwave • Door activated switch with cut-out to hotplates
	Group 1	£1190		£1140	
	Group 2	£1415		£1365	
	Group 3	£1515		£1465	
1.2M HIDEAWAY with MICROWAVE  W:1200 D:620 H:2100	Finish	HA06		HA04	<ul style="list-style-type: none"> • White laminate carcass • 1 1/2 bowl Stainless steel sink & drainer • 85ltr integrated refrigerator with ice box • Storage cupboard • With or without electric hotplates • 60 minute safety timer with hotplates • 700-watt compact microwave • Top unit with shelving, light & socket • Ceramic hob – Additional cost of £125 only available on HA06 (use code HA06 C)
	Group 1	£1215		£1165	
	Group 2	£1470		£1420	
	Group 3	£1575		£1525	
1.2M HIDEAWAY with MICROWAVE and DRAWER  W:1200 D:620 H:2100	Finish	HA08		HA10	<ul style="list-style-type: none"> • White laminate carcass • 1 1/2 bowl Stainless steel sink & drainer • 70ltr integrated refrigerator with ice box • Storage cupboard & drawer • With or without electric hotplates • 60 minute safety timer with hotplates • Top unit with shelving, light & socket • 700-watt compact microwave • Door activated switch with cut-out to hotplates
	Group 1	£1255		£1205	
	Group 2	£1510		£1460	
	Group 3	£1615		£1565	
600MM HIDEAWAY with MICROWAVE and DRAWER  W:600 D:620 H:2100	Finish	HA014	HA015	HA016	<ul style="list-style-type: none"> • White laminate carcass • Stainless steel sinktop • 70ltr integrated refrigerator with ice-box • With or without electric hotplates • 60 minute safety timer with hotplates • Drawer above fridge • Left or right hand hinged door • Top unit with shelving, light & socket • 700-watt compact microwave • Door activated switch with cut-out to hotplates
	Group 1	£995	£975	£950	
	Group 2	£1195	£1175	£1150	
	Group 3	£1255	£1235	£1210	

Please refer to page 18 of colour brochure for Group finishes.

- Prices are subject to change without prior notice
- All prices exclude VAT
- Delivery costs are charged according to postcode, model and quantity required
- Please refer to separate sheet for delivery charges

Hideaway Mini-Kitchens

Additional Items

see brochure pages 14 – 19

TALL STORAGE UNIT



W:400/500/600 x D:620 x H:2100

FINISH	400 WIDE	500 WIDE	600 WIDE
Finish	LSK40	LSK50	LSK60
Group 1	£290	£300	£310
Group 2	£305	£315	£325
Group 3	£355	£365	£375

- White laminate carcass
- Fitted with shelves
- Left or right hand hinged doors
- Available as a wardrobe with hanging rail
- LSK60 can be used to house a microwave, compact dishwasher or washing machine

TALL SIDE PANEL

W:600 x D:18 x H:2100

Finish	HSF		
Group 2	£85		
Group 3	£95		

- Finished 'Plant on' side panel to match doors

SPLASH BACK

Finish Stainless steel	SSB10 £120	SSB12 £145	
----------------------------------	-----------------------------	-----------------------------	--

- Stainless steel sheet splashback for 1000mm & 1200mm wide top units

Backboards for Kitchenettes, Galley & Oven Combi Kitchens see brochure page 18

BACKBOARDS



W:1000/1500/1600 x H:530

Finish	BB10 1000 x 530	BB15 1500 x 530	BB16 1600 x 530
Jamocho Granite Effect & Brushed Aluminium Laminate	£80	£115	£125
Stainless Steel	£120	£225	£240

- Alternative to wall tiles
- Suitable for wet areas
- Laminate or Stainless Steel finish
- Side panels available on request in brushed aluminium laminate effect finish BASP06 600 x 530 @ £50

Worktops for Galley & Oven Combi Kitchens see brochure page 18





WORKTOPS







Finish	Galley 500 x 600 Included	Oven Combi 600 x 600 Included
White		
Blocked Beech, Brushed Aluminium Laminate & Granite Effect	£25	£35
Stainless Steel	£115	£135

- Latest technology laminate
- 30mm postformed edge
- Moisture and Heat resistant
- Stainless steel option

Taps see brochure page 19





<p>DCM104</p> 	<p>CRU</p> 	<p>DLT104</p> 	<p>SL5/CH</p> 	<p>CB</p> 
<ul style="list-style-type: none"> • Chrome monobloc mixer tap • Chrome metal heads • Swivelling spout <p>£42</p>	<ul style="list-style-type: none"> • Chrome monobloc mixer tap • 1/4 turn ceramic disc • Swivelling spout <p>£52</p>	<ul style="list-style-type: none"> • Chrome monobloc mixer tap • 3" levers for easy use • 1/4 turn ceramic disc • Swivelling spout <p>£95</p>	<ul style="list-style-type: none"> • Chrome monobloc mixer tap • Single lever action • Swivelling spout <p>£30</p>	<ul style="list-style-type: none"> • Wooden chopping board for Electrolux mini-kitchens • Fits over single bowl <p>£48</p>

Water Heaters & Boiling Water Units see brochure page 19

<p>WHVT</p>  <p>W:290 D:178 H:477</p>	<p>RP1</p>  <p>W:307 D:74 H:160</p>	<p>PBW</p>  <p>W:230 D:138 H:298</p>	<p>BP1</p> 
<ul style="list-style-type: none"> • Vented undersink water heater • 7 litre capacity • 3kw rating • Fast heat up • Chrome monobloc vented tap <p>£295</p>	<ul style="list-style-type: none"> • Instantaneous undersink water heater • 9.5kw multi point • 40 amp fuse rating • Can be used with any monobloc tap • Compact size <p>£195</p>	<ul style="list-style-type: none"> • Boiling water unit • Ideal for making tea, coffee instant soups etc • 2.4 kw rating/2.0 litre capacity • Larger capacity models available • 3 year on-site warranty <p>£565</p>	<ul style="list-style-type: none"> • Instant boiling water for Tea, coffee etc • Chrome executive tap • Unit & filter fits under sink • Refills & re-boils automatically • Standard 13 amp socket • Easy fit <p>£450</p>

Washing Machine, Dishwasher & Microwave Options see brochure page 19

(Microwave options not available for mini-kitchens on brochure pages 5,6,8 and 9)

<p>CWM</p>  <p>W:495 D:515 H:670</p>	<p>CDW</p>  <p>W:545 D:480 H:447</p>	<p>R27STM</p>  <p>W:460 D:380 H:275</p>	<p>CM554W / CM579S</p>  <p>W:510 D:390 H:304</p>
<ul style="list-style-type: none"> • Compact washing machine • 1300 rpm • 3kg wash • Super rinse <p>£475</p>	<ul style="list-style-type: none"> • Compact Dishwasher • 6 place settings • 2 temperatures • 5 programmes • Cold water fill <p>£325</p>	<ul style="list-style-type: none"> • Compact Microwave • 800 watt output • 22 litre interior • Express cook feature • Stainless steel exterior <p>£90</p>	<ul style="list-style-type: none"> • Slimline Combination microwave, convection oven & grill • 27 litre capacity • 6 power levels • 1000 watt output • 1300 watt grill • Convection 100-220°C <p>CM554W £175 - White finish CM579S £235 - Stainless Steel finish</p>

Italian Hideaways see brochure pages 20 – 22

- Accessories such as utensil rails, halogen lights & chopping board are at additional cost
- These kitchens are available without hotplates, but with either a s/steel or laminate worktop

- Allow 6-8 weeks for delivery
- The Italian Hideaway Kitchen is supplied partly with assembled units & partly with flat pack sections



W:1256 D:602 H:1980

ITH320 £2175

- Matching carcass, backboard & doors
- Stainless steel sink & drainer
- Single lever monobloc tap
- Rear & side upstands
- Sink base with internal drawer
- Plate rack/drainers
- Bi-fold doors
- 2 plate electric hob
- Integrated refrigerator
- Recirculating or ducted extractor



W:1706 D:602 H:1980

ITH460 £2675

- Matching carcass, backboard & doors
- Stainless steel sink & drainer
- Single lever monobloc tap
- Rear & side upstands
- Sink base with internal drawer
- Plate rack/drainers
- Bi-fold doors
- **450mm base unit**
- 450mm open shelf unit
- 2 or 4 plate electric hob
- Integrated refrigerator
- Recirculating or ducted extractor



W:1706 D:602 H:1980

ITH580 £2995

- Matching carcass, backboard & doors
- Stainless steel sink & drainer
- Single lever monobloc tap
- Rear & side upstands
- Sink base with internal drawer
- Plate rack/drainers
- Bi-fold doors
- **450mm integrated dishwasher**
- 450mm open shelf unit
- 2 or 4 plate electric hob
- Integrated refrigerator
- Recirc/ducted extractor



W:1706 D:602 H:1980

ITH570 £2995

- Matching carcass, backboard & doors
- Stainless steel sink & drainer
- Single lever monobloc tap
- Rear & side upstands
- Sink base with internal drawer
- Plate rack/drainers
- Bi-fold doors
- **450mm multi-function oven**
- 450mm open shelf unit
- 2 or 4 plate electric hob
- Integrated refrigerator
- Recirculating or ducted extractor

Italian Contemporary Kitchens see brochure pages 23 – 25

These kitchens are part of a multi-system and are therefore available in a wide range of finishes and sizes.

(Grey Kitchen)



W:1800 D:600 H:2430

ITK1 £1995 brochure page 23

- Stainless steel sink & drainer
- Single lever monobloc tap
- 600mm sink base unit
- 600mm hob base unit
- 1800 x 600 x 40 laminate worktop
- 600mm tall wall unit with plate rack
- 600mm tall wall unit
- 600mm extractor wall unit
- 2 or 4 plate electric hob
- Integrated refrigerator
- Recirculating or ducted extractor

(Blue Kitchen)



W:2400 D:600 H:2190

ITK2 £2650 brochure page 23

- Stainless steel sink & drainer
- Single lever monobloc tap
- 600mm sink base unit
- 600mm oven housing unit
- 600mm drawer unit
- 2400 x 600 x 40 laminate worktop
- 600mm wall unit with plate rack
- 2 No. 600mm wall units
- 600mm extractor wall unit
- 4 plate electric hob
- Single multi-function oven
- Integrated refrigerator
- Recirculating or ducted extractor

(White Kitchen)



W:2400 D:600 H:2190

ITK3 £2225 brochure page 25

- Stainless steel sink & drainer
- Single lever monobloc tap
- 600mm sink base unit
- 600mm hob base unit
- 600mm drawer unit
- 2400 x 600 x 40 laminate worktop
- 600mm wall unit with plate rack
- 2 No. 600mm wall units
- 600mm extractor wall unit
- 4 plate electric hob
- Integrated refrigerator
- Recirculating or ducted extractor

Kitchens for wheelchair use



FINISH	2 Hotplates	Without Hotplates
Finish	ETN1081	ETN1083
Group 1	£445	£400
Group 2	£495	£450
Group 3	£510	£465

Check stock availability or allow 4 – 6 weeks for delivery.

- White laminate carcase
- Stainless steel sink & drainer
- With or without electric hotplates
- 60-minute safety timer with hotplates
- Cutlery drawer
- Wall hung adjustable brackets



Finish	ETN1281	ETN1283
Group 1	£475	£430
Group 2	£525	£480
Group 3	£540	£495

- White laminate carcase
- 1 1/2 bowl stainless steel sink & drainer
- With or without electric hotplates
- 60-minute safety timer with hotplates
- Cutlery drawer
- Wall hung adjustable brackets

Solutions for compact living



Folding Tables

“Where space is at a premium John Strand MK presents, the Convertables, a range of designer coffee table that convert into dining tables. Simple to use and available in a choice of finishes.



Smartbeds

Smartbeds have products with single, double & king-size mattress options. The wallbeds include combinations with shelves sofa, table, desk & revolving mechanisms.



Kitchoo

John Strand MK is delighted to announce the arrival of Kitchoo; a luxury small kitchen range that combine ingenuity, beautiful design and excellent ecological credentials. www.kitchoo.com”

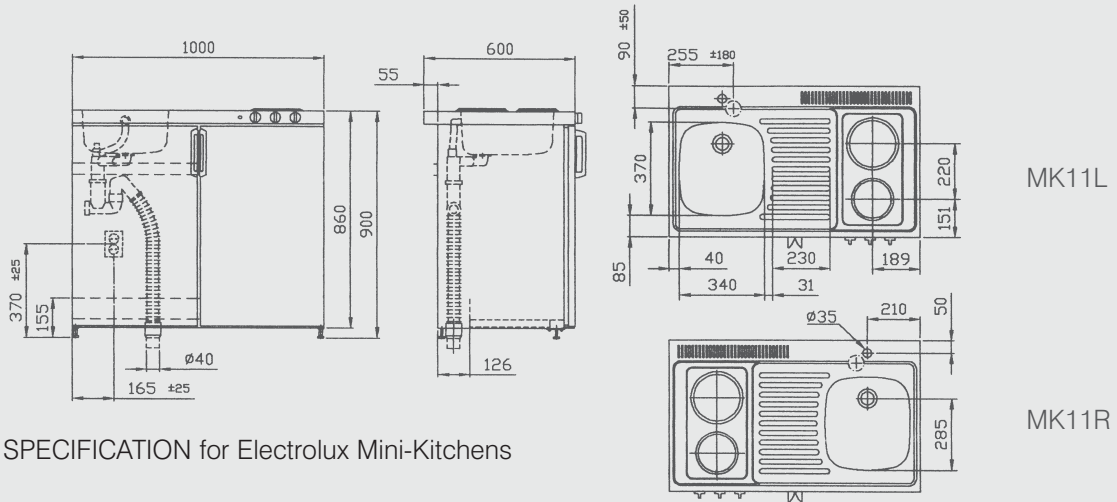

GENERAL SPECIFICATION for Electrolux Mini-Kitchens

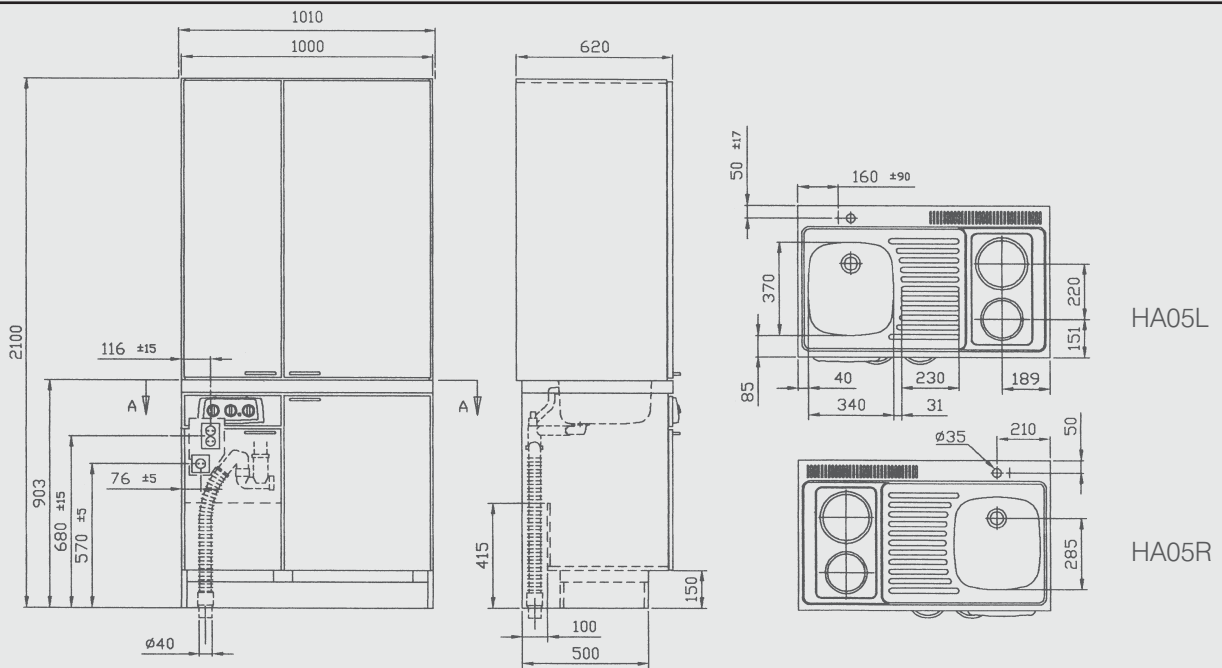

GENERAL SPECIFICATION for 1m wide Electrolux Hideaway Kitchens (illustrated with hotplates)

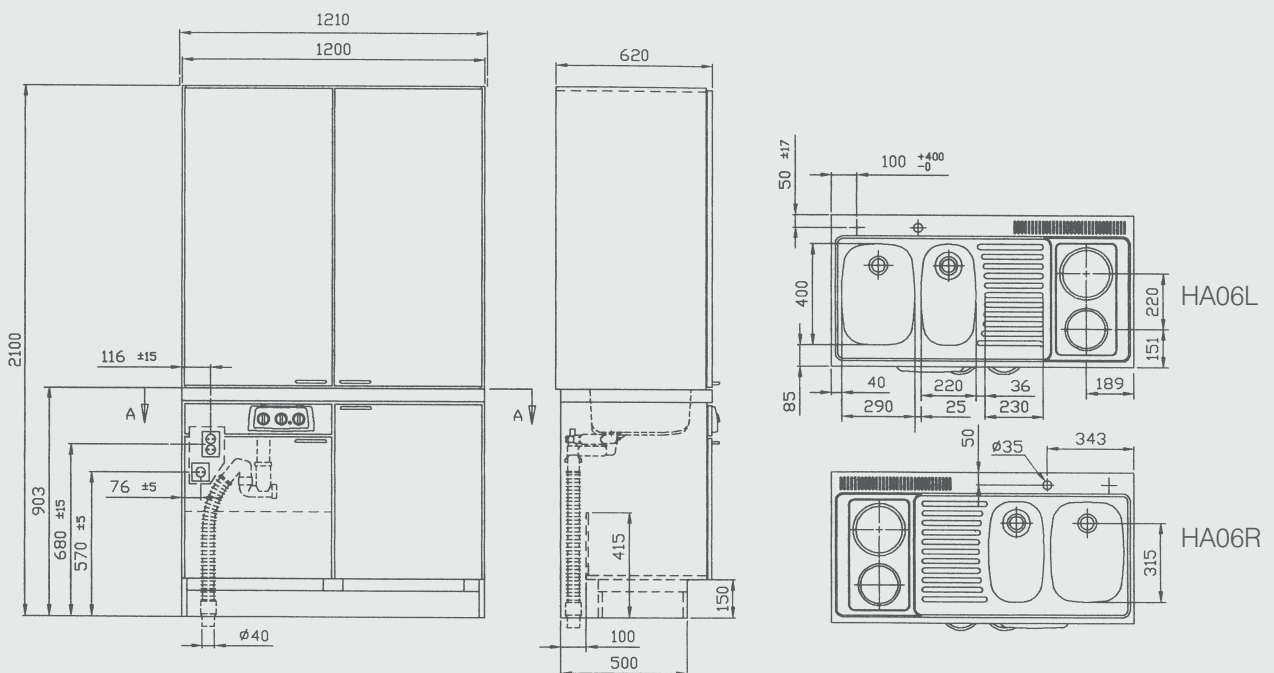

GENERAL SPECIFICATION for 1.2m wide Electrolux Hideaway Kitchens (illustrated with hotplates)

TECHNICAL DATA FOR MINI-KITCHENS

SINKTOP

All Stainless steel construction
35mm cut out for monobloc tap
Complete with waste, trap & overflow fittings for 40mm connection
Specify Left or Right hand bowl

ELECTRICAL DATA

Voltage 230 – 240V / 50Hz / 13A
Total wattage incl. refrigerator 2300W
The Mini-kitchen is supplied with two electrical leads with earthed plugs for the hotplates and refrigerator
Connect to a single phase 13A supply
We recommend one socket per appliance

REFRIGERATORS

Mini-kitchens
98ltr with 4 star freezer - 100W
Hideaway Mini-kitchens
85ltr capacity with icebox - 95W
or 70ltr capacity with icebox - 95W

HOTPLATES

145 dia. 1000W
180 dia. 1200W
Operated by a 60 minute timer with automatic cut-out

MICROWAVES

(All models except Oven Combi)
Compact Microwave 700W output
20 ltr capacity 5 power levels
Combination Microwave (Oven Combi Kitchens)
900W output 26 ltr capacity
1850W Quartz grill
Convection oven (40-250 C)

BASE AND WALL UNITS

Units are supplied flatpacked
Matt white melamine finish
18mm carcass, 90 hinges, 'D' handles
40mm postformed worktop
Wall units 500w / 1000w x 300d x 570h
Base unit 500w x 600d x 900h

18mm carcass for Designer and Oven Combi Kitchens.
All supplied assembled

INSTALLATION

The Mini-Kitchen should be installed so that it can be pulled forward from the wall to allow for servicing access.

Waste and water supplies should be positioned on the side of the sink as access behind the refrigerator is limited.

The Mini-Kitchen complies with requirements of the following EU directives:

- 73/23/EEC, dated 19.02.1973 – low voltage directive
- 89/336/EEC, dated 03.05.1989 (incl. amendment)
- 92/31/EEC) directive on electromagnetic compatibility

Appliances are covered by the Manufacturers Guarantee.

We reserve the right to change the specification without prior notice. If a particular point is critical to you please check before you purchase.

E & OE

JOHN STRAND (MK) LTD CONDITIONS OF TRADE

1. GENERAL

In these conditions:
"Seller" means John Strand (MK) Ltd.
"Buyer" means the person, firm or company who places an order with the Seller for the manufacture and/or supply of any goods

2. ACCEPTANCE

Orders are subject to these Conditions of Trade. Any different conditions on the Buyer's document will only apply if the Seller agrees in writing.

3. TERMS

Payment for goods must be made before delivery. Where customers have approved accounts, these are due for settlement 30 days from the date of invoice. Accounts are payable strictly nett.

4. PRICES

Unless otherwise agreed by the Seller in writing, quotations are held open for acceptance for a period of 12 weeks from the date they are issued. The prices charged will be the prices supplied by the Seller and are exclusive of VAT.

5. DELIVERY PERIOD

Time of delivery will not be of the essence of the contract. The period quoted for delivery commences on the date the order is acknowledged but is an estimate only. While the Seller will use all reasonable commercial endeavours to deliver the goods by the date specified, the Seller will not be liable in any way for unforeseen delays.

6. LOSS OR DAMAGE IN TRANSIT

Any damages or shortages must be reported to the Seller within 3 working days and the Delivery Note must be marked 'Damaged or Goods Missing'. Otherwise it will be deemed that the goods have been received 'Complete' and in 'Good Condition'.

7. RISK

The risk in the goods will pass to the Buyer on delivery and in the event of the goods being later lost or destroyed by fire or burglary or due to any other mishap or accident the Buyer will still be responsible to the Seller for payment.

8. DEFECTIVE MATERIALS AND GOODS

The Buyer will have the benefit of and be subject to such product guarantees of quality as the Seller may from time to time provide in respect of goods manufactured and/or supplied by the Seller and the Buyer is deemed to have full knowledge of the terms of such guarantees. Copies of the guarantees will be supplied by the Seller on request. The seller makes no other representations or warranties in relation to the goods other than those contained in the guarantees.

Subject to the provisions of such guarantees and to the extent that is permitted by law, the Seller excludes its liability for any loss or damage suffered by the Buyer in connection with the goods or their use.

9. ALTERATION TO DESIGN AND SPECIFICATION

The Seller reserves the right to alter, modify or improve the design or specification of any goods without notification.

10. CANCELLATION OF ORDERS

We regret that the Seller is unable to accept cancellation of orders for goods manufactured to customer's special requirements unless first agreed by the Seller in writing. All other cancellations will be subject to a 25% charge against the cost of the goods ordered for re-stocking. Additional delivery and collection charges will apply.

11. OWNERSHIP

The legal ownership of all goods ordered will remain with the Seller until full payment has been received from the Buyer.